

ANGLE	± 5°	REV	LOCAS	DESCRIPTION	DESIGN	DATE	卫国强
X.XXX	± 0.05	01			DRAWN	DATE	尚伟
X.XX	± 0.15	02			CHECKED	DATE	吴汉学
X.X	± 0.25	03			AUDITED	DATE	龚劲松
X	± 0.50	04			APPROVED	DATE	eric

Specifications/备注 (Remark)

1-材料 (MATERIAL)
 胶芯: PA6T+30%G.F UL94V-0, 颜色: 黑色
 Housing: PA6T+30%G.F UL94V-0, Color: Black
 四方针: 黄铜/镍底30u"MIN/表面镀金0.8u"MIN
 Contact: Brass/0.8u"MIN GOLD PLATING
 OVER ALL 30u"MIN NICKEL UNDERPLATING
 OVER ALL

2-特性 (characteristics):
 额定电流: 1 AMP
 Raring Current: 1 AMP
 接触阻抗: 20mΩ MAX.
 Contact Resistance: 20mΩ MAX.
 绝缘阻抗: 1000MΩMIN.
 Insulating Resistance: 1000MΩMIN.
 耐电压: AC 500V.
 Withstanding Voltage: AC 500V.
 温度范围: -40度至+105度
 Temperture Range: -40°Cto +105°C

ORDERING INFORMATION

23XX-11 XX XX X MU X 1

NO.OF PINS PER ROW 02-50P	INSULATOR MATERIAL B:PA6T C:PA9T D:LCP	PACKING A:PE Bag B:TOPE&REED C:TUBE D:TUBE+CAP E:TRAY
---------------------------------	--	--

CONTACT PLATING
 FULL OF GOLD SEMI-GOLD
 A0=0.8u" B0=0.8u"

 A9=30u" B9=30u"
 S1=ORDINARY TIN PLATED
 S2=MATTE TIN PLATED
 S3=TIN-PLATED HIGH-TEMPERATURE

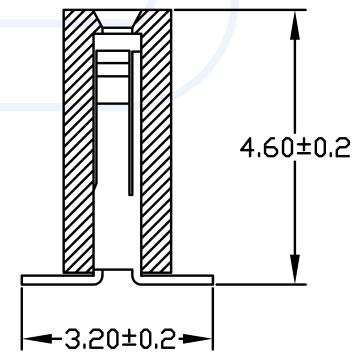
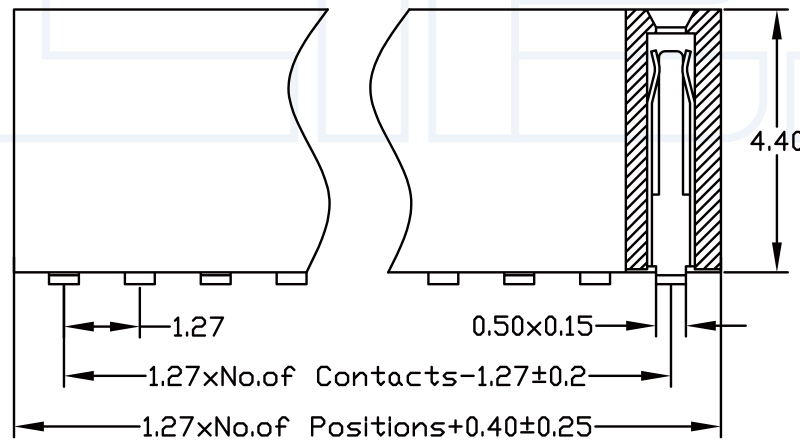
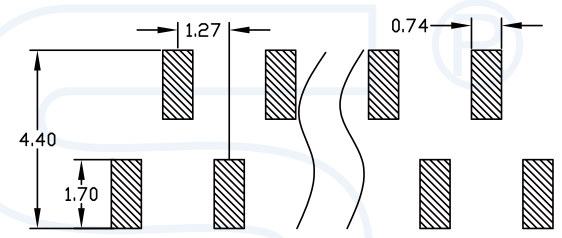
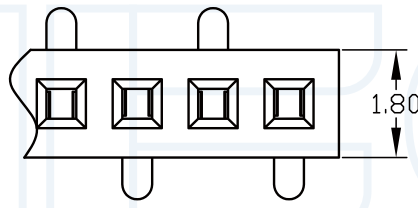
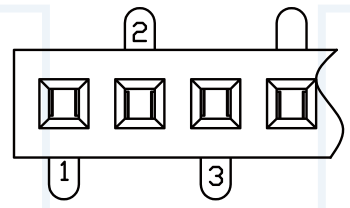
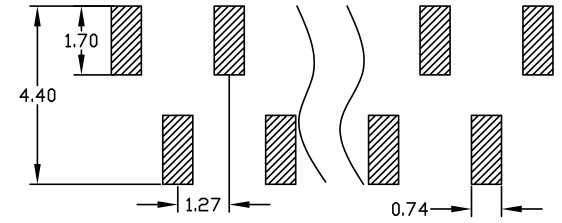
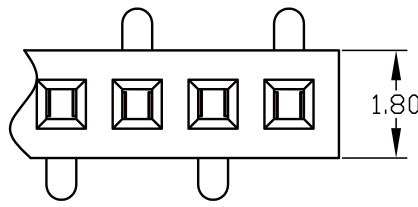
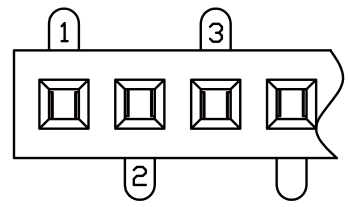

YLIES 东莞市瑞翔精密连接器有限公司
 DONG GUAN YLIES PRECISE CONNECTOR CO.,LTD

Tel:0769-85381995 / Fax:0769-85493987 / Email: ylies@ylies.cn / Web:www.ylies.cn

TITLE 95-1.27mm 单排排母 SMT DATE 2018-02-18

PROJECTON REV A UNIT mm SCALE 1:1 PAGE 1/1

PART NO: 2321-11XXXXXXMUX1 2334/2344-11XXXXXXMUX1 DRAWING NO: